

Easier to use or modify on 1000 pcs or more: We will quote other bends or lengths accurately cut length, chamfered with CNC, screw machines.

Slam designs that change orientation of chamfer or handle from knife to flat

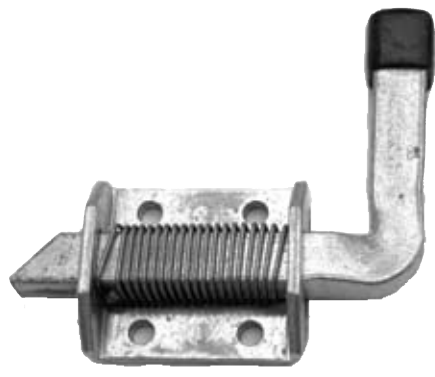

784 Heavy



3" Body 3/4" diameter dead-bolt: pin extension 1.56" standard but requires minimum order: customer supplies the cable release.



WEIGHT EACH

714 "A" BODY WIDTH STEEL(1/4" PIN) 0.12

714 "A" BODY WIDTH STAINLESS STEEL 0.12

SEE CHART FOR OTHER PIN DIAMETERS IN THIS STYLE

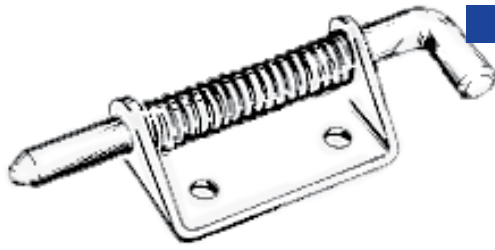

719 STEEL(3/8" PIN) 0.26

719 STAINLESS STEEL 0.26

720 STEEL(1/2" PIN) 0.64

720 STAINLESS STEEL 0.64

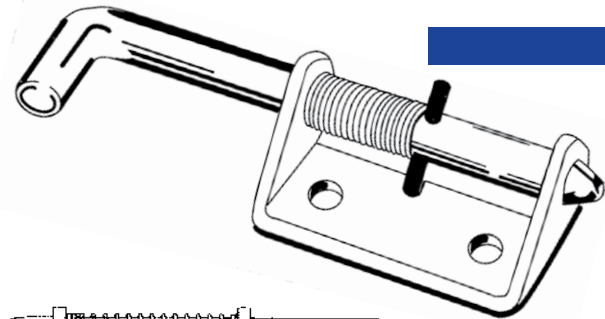

719WHB STEEL 0.26

719WHB STAINLESS STEEL 0.26

720WHB STEEL 0.26

720WHB STAINLESS STEEL 0.26

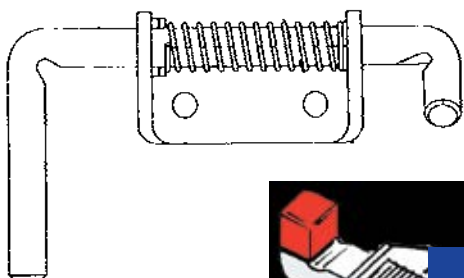
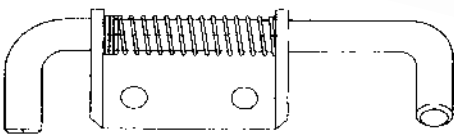

719HL STEEL (3/8" HOOK PIN) 0.30

720HL STEEL (1/2" HOOK PIN) 0.80

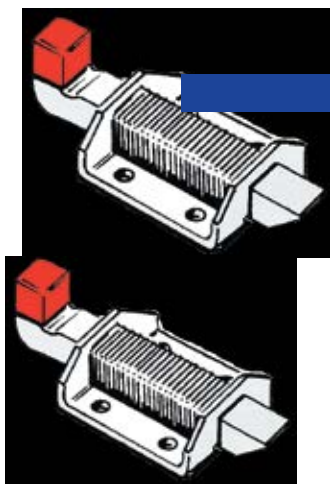
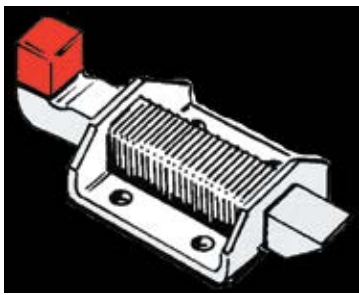

707 STEEL(3/8" SQUARE PIN) 0.18

707 STAINLESS STEEL 0.18

708 STEEL(7/16" SQUARE PIN) 0.40

709 STEEL(1/2" SQUARE PIN) 0.78

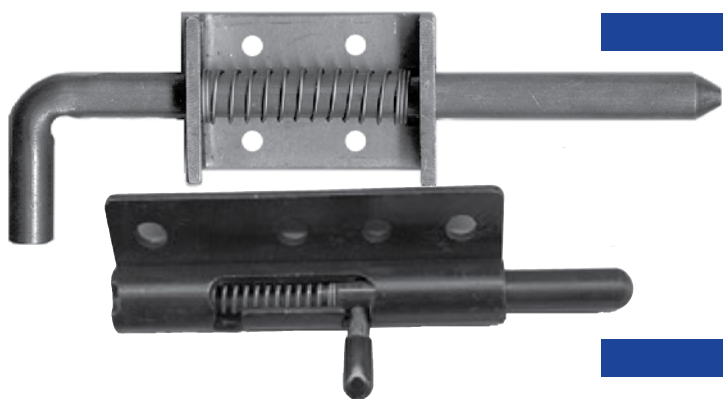

785 STEEL(3/8" PIN) 0.32

780 STEEL(3/8" PIN, TEFLON COATED) 0.28

OPTIONAL COVERS

707 STEEL

707 STAINLESS STEEL

708 STEEL

709 STEEL

